

K6D80 1kN/50Nm/MP11



Description

The multi-component sensor K6D80 allows force and torque measurement in three mutually perpendicular axes.

The multi-component sensor K6D80 distinguishes itself by a big measuring range for torques at the same time with the small outer diameter.

With this multi-component sensor of the „second generation“ is used rod construction, which absorbs forces and torques directly on the pitch circle of the fastening thread. Thereby, the maximum stiffness and the biggest measuring range will be achieved for the torques.

The force transmission is applied on the 1 mm raised segments. The inner diameter of segments is used for the centering. Due to segmented, ring-shaped front surface, the optimal force transmission and therefore the best possible reproducibility in the range of about 0,1 % will be obtained.

The multi-component force sensor is very well suited for use in robotics, e.g.

- For collision detection
- "Teach-In"
- Presence detection and error detection
- Force or torque-controlled operation
- Load measurement in medicine, prosthetics, orthopaedic engineering or gait analysis
- Measurement in sports medicine
- Comfort / ergonomics measurements

The force and torque loadings are evaluated e.g. using a GSV-8AS measurement amplifier or an integrated electronic of type GSV-6.

The sensor K6D80 2kN/100Nm is made of aluminium alloy, the sensor K6D80 5kN/250Nm is made of high-strength stainless steel 1.4542.

Dimensions

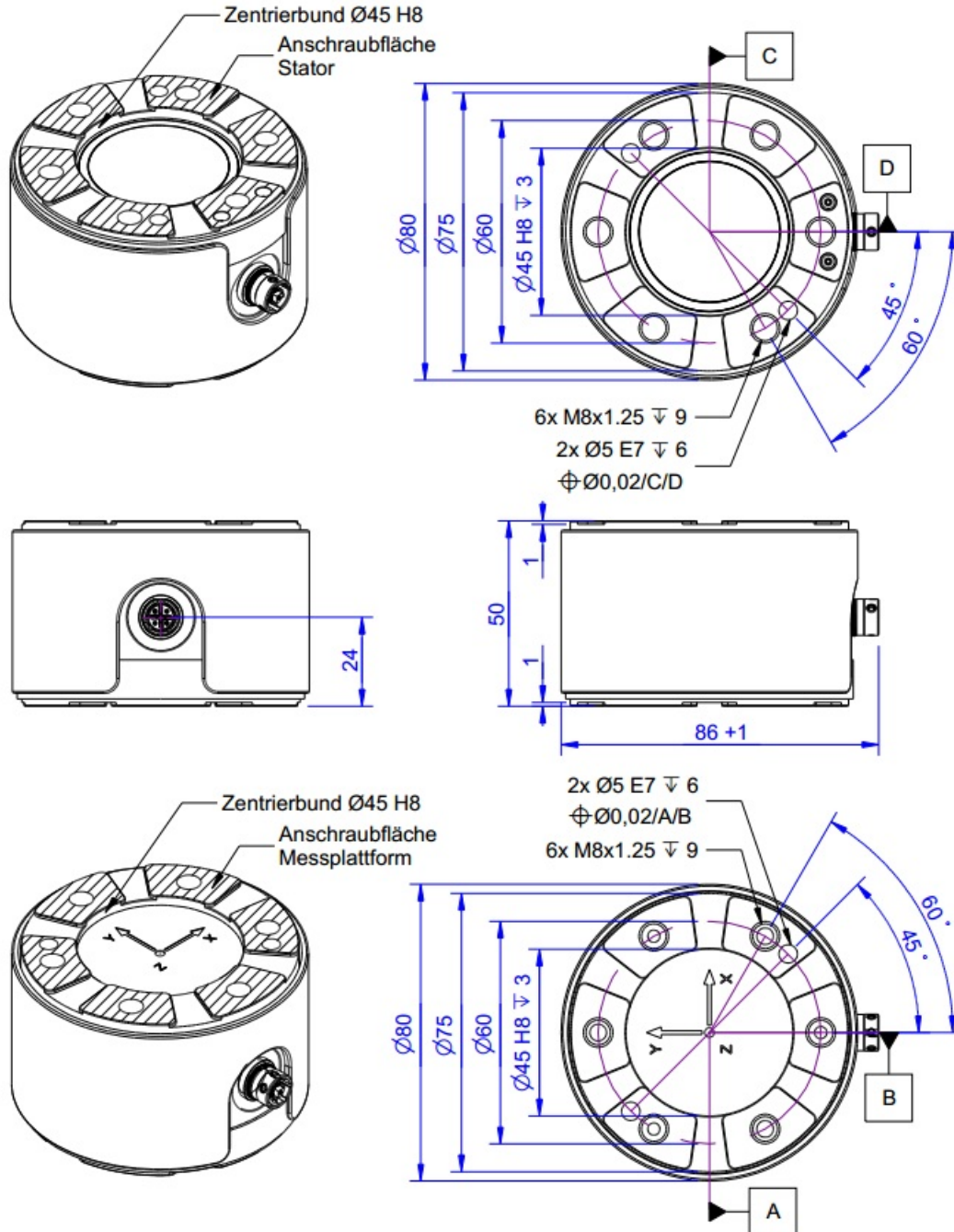

Technical Data

Force sensor

Type	6-Axis force sensor
Force direction	Tension / Compression
Rated force Fx	1 kN
Rated force Fy	1 kN
Rated force Fz	2.5 kN
Force introduction	Inner thread
Dimension 1	6x M8x0,1,25
Sensor Fastening	Inner thread
Dimension 2	6x M8x0,1,25
Operating force	300 %FS
Rated displacement	0.05 mm
Twist	0.04 rad
Material	Aluminium alloy
Natural frequency	2.4 kHz
Dimensions	Ø80 x 50 mm
Height	50 mm
Length or Diameter	80 mm
Rated torque Mx	50 Nm
Rated torque My	50 Nm
Rated torque Mz	50 Nm
Torque limit	300 % FS
Bending moment limit	300 % FS
Breaking force	600 %

Electrical Data

Input resistance	350 Ohm
Tolerance input resistance	10 Ohm
Output resistance	350 Ohm
Tolerance output resistance	10 Ohm
Insulation resistance	2 GOhm
Rated range of excitation voltage f	2.5 ... 5 V
Operating range of excitation voltage f	1 ... 5 V
Zero signal to	-0.05 mV/V
Zero signal from	0.05 mV/V
characteristic value range min	0.5 mV/V
characteristic value range max	0.8 mV/V

Precision data

Accuracy class	0,2%
Relative linearity error	0.1 %FS
Relative zero signal hysteresis	0.1 %FS
Temperature effect on zero signal	0.1 %FS/K
Temperature effect on characteristic value	0.05 %RD/K
Relative creep	0.1 %FS



Relative repeatability error	0.5 %FS
------------------------------	---------

Connection Data

Connection type	Connector
Name of the connection	MP11, 24-pole, male

Eccentricity and Crosstalk

Crosstalk	1 %FS
-----------	-------

Environmental data

Rated temperature range f	-10 ... 70 °C
Operating temperature range f	-10 ... 85 °C
Storage temperature range f	-10 ... 85 °C
Environmental protection	IP65

Abbreviation : RD: „Reading“; FS: „Full Scale“;

The application of a calibration matrix is required for the determination of the forces F_x , F_y , F_z and moments M_x , M_y , and M_z from the 6 measurement channels, and to compensate for the crosstalk.

The calibration data are individually determined and documented for the sensor.

The measurement error is expressed individually by the specification of the extended measurement uncertainty ($k = 2$) for the forces F_x , F_y , F_z , and moments M_x , M_y , M_z .

Pin Configuration

Channel	Symbol	Description	Wire colour	PIN
1	+Us	positive bridge supply	yellow	14
	-Us	negative bridge supply	green	13
	+Ud	positive bridge output	white	1
	-Ud	negative bridge output	brown	5
2	+Us	positive bridge supply	gray	15
	-Us	negative bridge supply	black	16
	+Ud	positive bridge output	red	7
	-Ud	negative bridge output	pink	6
3	+Us	positive bridge supply	brown-blue	23
	-Us	negative bridge supply	white-red	24
	+Ud	positive bridge output	brown-red	12
	-Ud	negative bridge output	white-pink	4
4	+Us	positive bridge supply	white-yellow	19
	-Us	negative bridge supply	yellow-brown	20
	+Ud	positive bridge output	brown-green	9
	-Ud	negative bridge output	white-green	3
5	+Us	positive bridge supply	white-gray	21
	-Us	negative bridge supply	white-blue	22
	+Ud	positive bridge output	gray-brown	10
	-Ud	negative bridge output	pink-brown	11
6	+Us	positive bridge supply	gray-pink	18
	-Us	negative bridge supply	purple	17
	+Ud	positive bridge output	red-blue	8
	-Ud	negative bridge output	blue	2
-	shield		transparent	

Shield: connected with sensor housing;



Manual

Stiffness Matrix K6D80 1kN/50Nm

25.2 kN/mm	0,0	0,0	0,0	629.3 kN	0,0	u_x
0,0	25.2 kN/mm	0,0	-629.3 kN	0,0	0,0	u_y
0,0	0,0	136.9 kN/mm	0,0	0,0	0,0	u_z
0,0	-629.3 kN	0,0	63.6 kNm	0,0	0,0	ϕ_{ix}
629.3 kN	0,0	0,0	0,0	63.6 kNm	0,0	ϕ_{iy}
0,0	0,0	0,0	0,0	0,0	35.2 kNm	ϕ_{iz}











Element	Description
[kN/mm]	force- displacement
[kNm]	torque- twist
[kN]	force- twist and torque- displacement

Mounting

The forces is applied to an annulus ($\emptyset 75\text{-}\emptyset 45$) on the end faces of the sensor. No force is applied to the area inside the ring.

A centring hole is provided to secure the angular position.

accessories

Description	Description
 K6D-CalibrationMatrix SL	Standard calibration matrix "Small load" for the sensors with small measuring ranges
 K6D-CalibrationMatrix SL/4	High accuracy calibration matrix for 6-axis force/torque sensors;
 GSV-8DS	8-channel amplifier with USB port, analog output, UART interface. Other versions GSV-8AS CAN with Canbus and GSV-8AS EC with EtherCAT fieldbus.
 GSV-8AS	8-channel amplifier with USB port, analog output, UART interface. Other versions GSV-8AS CAN with Canbus and GSV-8AS EC with EtherCAT fieldbus.
 K6D-Adapter Development	Indicative offer for an adapter set, Consisting of e.g. 2 plates, For mounting a device / flange on K6D sensor;
 Connection cable MP11/f-M16/24p/m	Connection cable for the K6D sensor to 8-channel measuring amplifier GSV-8AS
 Connection cable MP11/f-M16/24p/m/angled	Angled connection cable for the K6D sensor to 8-channel measuring amplifier GSV-8AS
 Connection cable MP11/f-D-Sub44HD/m	Connection cable for connecting the K6D sensor to an 8-channel measuring amplifier GSV-8DS SubD44HD
 Connection cable MP11/f-D-Sub44HD/m/straight	Straight connection cable for connecting the K6D sensor to an 8-channel measuring amplifier GSV-8DS SubD44HD
 Connection cable MP11/f-D-Sub44HD/m/angled	Angled connection cable for connecting the K6D sensor to an 8-channel measuring amplifier GSV-8DS SubD44HD
 Connection cable MP11/f-open end	Connection cable for K6D sensor