

K6D175 10kN/1kNm, 20kN/2kNm, 50kN/5kNm



Description

The K6D175 multi-axis sensor is designed for measuring force and torque in three mutually perpendicular axes. The measurement ranges for the forces and moments can be factory adapted in a wide range. The K6D175 was developed for the following applications:

- Robotics
- Measurements in automation technology.

The force and torque loadings are evaluated e.g. using a GSV-1A8USB measurement amplifier. The 6 load values can be calculated using a Windows DLL or using LabVIEW with the aid of a digital calibration document provided. The calibration document contains the individual calibration factors and error corrections for the sensor.

Dimensions

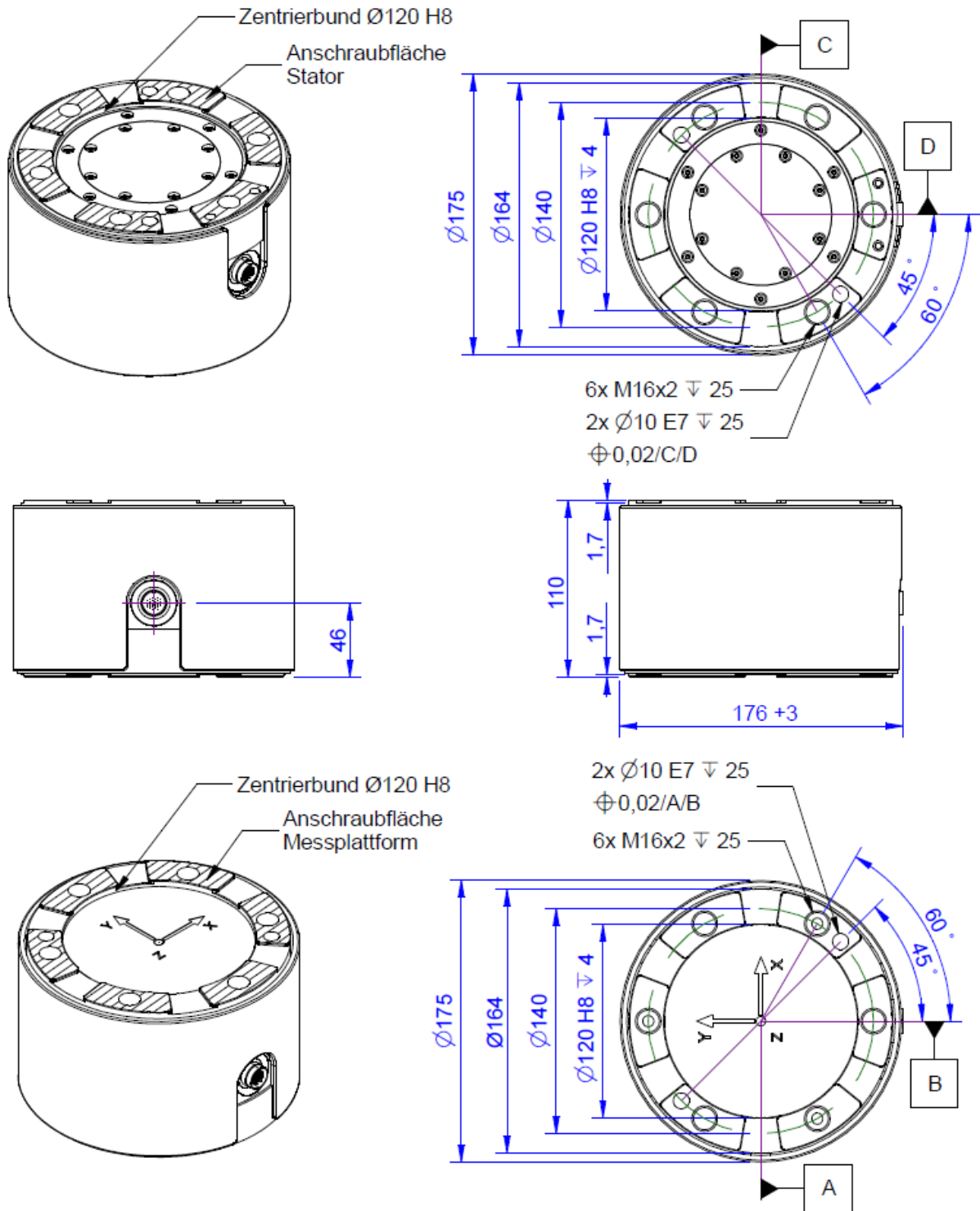



Technical Data

Kraftsensoren

Type	6-Axis force sensor
Force direction	Tension / Compression
Force introduction	Inner thread
Dimension 1	6 x M16x2
Sensor Fastening	Inner thread
Dimension 2	6 x M16x2
Operating force	200 %FS
Rated displacement	0.1 mm
Twist	0.01 rad
Material	Stainless steel
Dimensions	Ø175 x 110 mm
Height	110 mm
Length or Diameter	175 mm
Torque limit	300 %FS
Bending moment limit	300 %FS

Elektrische Daten

Input resistance	350 Ohm
Tolerance input resistance	10 ±
Output resistance	350 Ohm
Tolerance output resistance	10 ±
Insulation resistance	2 GOhm
Rated range of excitation voltage f	2.5 ... 5 V
Operating range of excitation voltage f	1 ... 5 V
nullsignalbereichMin	-0.05 mV/V
nullsignalbereichMax	0.05 mV/V

Precision

Relative linearity error	0.1 %FS
Relative zero signal hysteresis	0.1 %FS
Temperature effect on zero signal	0.1 %FS/K
Temperature effect on characteristic value	0.05 %RD/K
Relative creep	0.1 %FS
Relative repeatability error	0.5 %FS



Connection Data

Name of the connection	M16 Rundsteckverbinder oder 26-24 PUR / 24x0,16 mm ²
------------------------	--

Temperature

Rated temperature range f	-10 ... 70 °C
Operating temperature range f	-10 ... 85 °C
Storage temperature range f	-10 ... 85 °C
Environmental protection	IP67

Abbreviation : RD: „Reading“; FS: „Full Scale“;

The application of a calibration matrix is required for the determination of the forces F_x , F_y , F_z and moments M_x , M_y , and M_z from the 6 measurement channels, and to compensate for the crosstalk.

The calibration data are individually determined and documented for the sensor.

The measurement error is expressed individually by the specification of the extended measurement uncertainty ($k = 2$) for the forces F_x , F_y , F_z , and moments M_x , M_y , M_z .



Pin Configuration

Channel	Symbol	Description	Wire colour	PIN
1	+Us	positive bridge supply	white	1
	-Us	negative bridge supply	brown	2
	+Ud	positive bridge output	green	3
	-Ud	negative bridge output	yellow	4
2	+Us	positive bridge supply	gray	5
	-Us	negative bridge supply	pink	6
	+Ud	positive bridge output	blue	7
	-Ud	negative bridge output	red	8
3	+Us	positive bridge supply	black	9
	-Us	negative bridge supply	purple	10
	+Ud	positive bridge output	gray-pink	11
	-Ud	negative bridge output	red-blue	12
4	+Us	positive bridge supply	white-green	13
	-Us	negative bridge supply	brown-green	14
	+Ud	positive bridge output	white-yellow	15
	-Ud	negative bridge output	yellow-brown	16
5	+Us	positive bridge supply	white-gray	17
	-Us	negative bridge supply	gray-brown	18
	+Ud	positive bridge output	white-pink	19
	-Ud	negative bridge output	pink-brown	20
6	+Us	positive bridge supply	white-blue	21
	-Us	negative bridge supply	brown-blue	22
	+Ud	positive bridge output	white-red	23
	-Ud	negative bridge output	brown-red	24

Shield: connected with sensor housing;



Manual

Stiffness Matrix K6D175 10kN/1kNm

178.1 kN/mm	0,0	0,0	0,0	10331 kN	0,0	u_x
0,0	178.1 kN/mm	0,0	-103314 kN	0,0	0,0	u_y
0,0	0,0	786.7 kN/mm	0,0	0,0	0,0	u_z
0,0	-10331 kN	0,0	2149.7 kNm	0,0	0,0	ϕ_x
10331 kN	0,0	0,0	0,0	2149.7 kNm	0,0	ϕ_y
0,0	0,0	0,0	0,0	0,0	1404.3 kNm	ϕ_z

Stiffness Matrix K6D175 20kN/2kNm

375.5 kN/mm	0,0	0,0	0,0	21800 kN	0,0	u_x
0,0	375.5 kN/mm	0,0	-21800 kN	0,0	0,0	u_y
0,0	0,0	1658.3 kN/mm	0,0	0,0	0,0	u_z
0,0	-21800 kN	0,0	4531.7 kNm	0,0	0,0	ϕ_x
21800 kN	0,0	0,0	0,0	4531.7 kNm	0,0	ϕ_y
0,0	0,0	0,0	0,0	0,0	4844.0 kNm	ϕ_z

Stiffness Matrix K6D175 50kN/5kNm

614.4 kN/mm	0,0	0,0	0,0	35600 kN	0,0	u_x
0,0	614.4 kN/mm	0,0	-35600 kN	0,0	0,0	u_y
0,0	0,0	2713.6 kN/mm	0,0	0,0	0,0	u_z
0,0	-35600 kN	0,0	7415.4 kNm	0,0	0,0	ϕ_x
35600 kN	0,0	0,0	0,0	7415.4 kNm	0,0	ϕ_y
0,0	0,0	0,0	0,0	0,0	4844.0 kNm	ϕ_z

Element	Description
[kN/mm]	force- displacement
[kNm]	torque- twist
[kN]	force- twist and torque- displacement

ME-Meßsysteme GmbH
Neuendorfstr. 18a
DE-16761 Henningsdorf

Tel +49 (0)3302 7 86 20 60
Fax +49 (0)3302 7 86 20 69

Mail info@me-systeme.de
Web www.me-systeme.de





Mounting

The force is applied to an annulus/to 6 segments of a circle, 155 mm – 140 mm in diameter, on the end faces of the sensor. No force is applied to the area inside the 140 mm in diameter ring.

The areas outside the annuli can be used for centring purposes. A centring hole is provided to secure the angular position.

accessories

Description	Description
	K6D-CalibrationMatrix HL
	GSV-8AS 8-channel amplifier with USB port, analog output, UART interface. Other versions GSV-8AS CAN with Canbus and GSV-8AS EC with EtherCAT fieldbus.
	Configuration 24p/m/M16 Round plug, 24 pole, configured with sensor cable
	GSV-8DS 8-channel amplifier with USB port, analog output, UART interface. Other versions GSV-8AS CAN with Canbus and GSV-8AS EC with EtherCAT fieldbus.
	Configuration SubD44/m/HD Connector Type SubD, 44 pins, male (male), with hood
	K6D-Adapter Development Indicative offer for an adapter set, Consisting of e.g. 2 plates, For mounting a device / flange on K6D sensor;
	Connection cable M16/24p/f-m16/24p/m Connection cable for K6D sensor to 8-channel measuring amplifier GSV-8AS;
	Connection cable M16/24p/f-SubD44HD/m Connection cable for K6D sensor to 8-channel measuring amplifier GSV-8DS D-Sub44HD;