

KM40e 500N/010



Description

The force sensor KM40e is a precision force sensor in membrane construction with integrated miniature electronics for the measurement of compressive forces. The force sensor is fastened to a flat surface with four screws M4. There is a spherical cap with a radius of 50 mm provided for the force transmission. The force is applied with a flat plate against the cap. The strength introduction occurs with a flat plate against the cap. The hardness of the spherical cap is HRC 54. A flattening of the spherical cap from a load of about 20kN is therefore possible.

Environmental protection rating is IP 67.

In contrast to the force sensors of series KD, KDs and LC the lateral forces from about 5% of the nominal load can lead to a measurement error greater than 1%. Therefore, the force transmission must be centric.

The sensor with integrated analog amplifier GSV-13i is a compact measuring system.

The electronics amplifies the strain gauge output signal and allows a simple and direct analog measurement in voltage (0... 10V).

Further variants for voltage (0... 5V) or current (4... 20mA) are available on request.

Dimensions

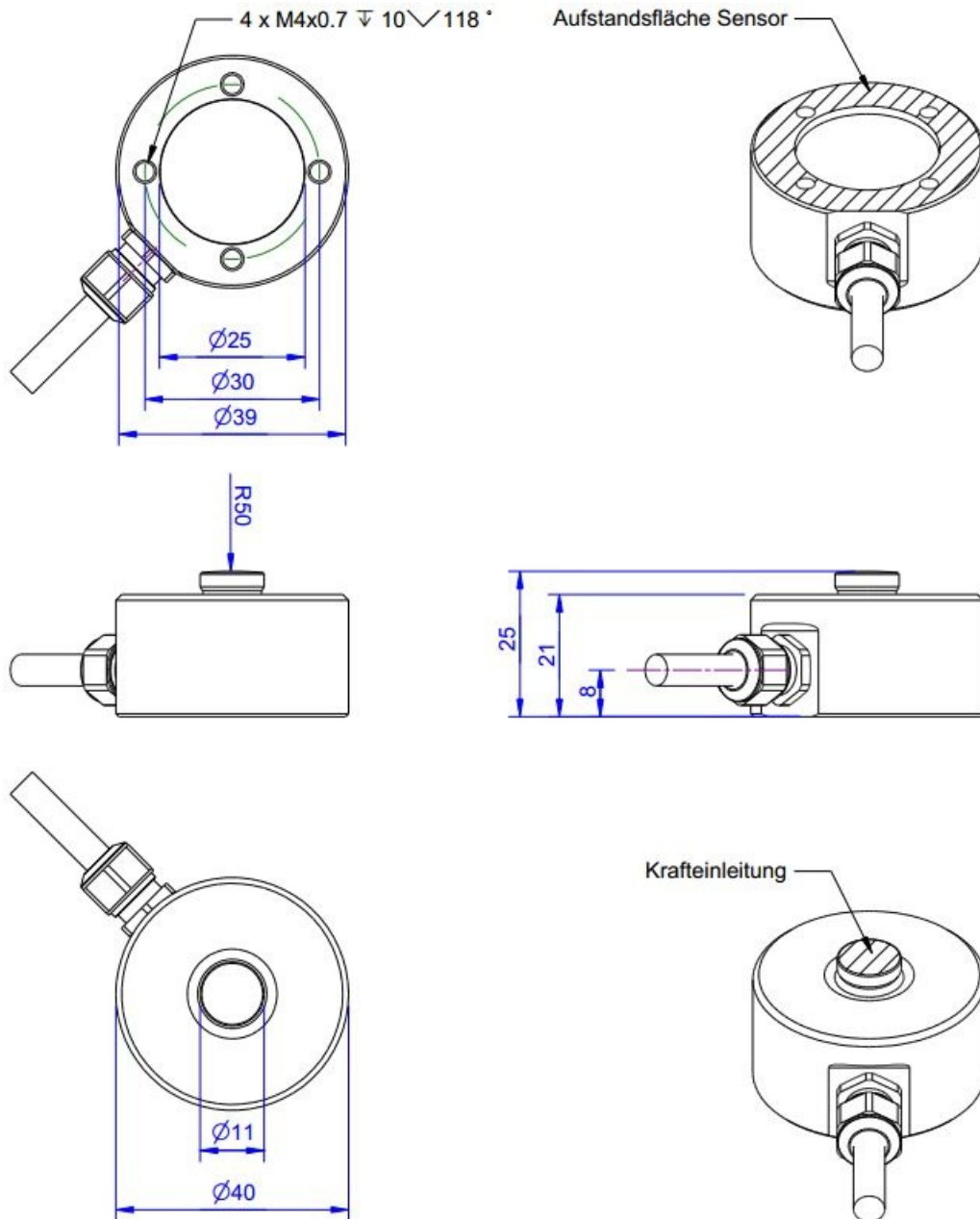

Technical Data

Force sensor

Type	Load cell
Force direction	Compression
Rated force F _x	500 N
Force introduction	Load button
Dimension 1	Ø11x4
Sensor Fastening	Circular ring
Dimension 2	Ø40x7,5
Operating force	150 %FS
Rated displacement	0.07 mm
Lateral force limit	50 %FS
Material	Stainless steel
Natural frequency	5 kHz
Height	25 mm
Length or Diameter	40 mm

Electrical Data

Input resistance	390 Ohm
Tolerance input resistance	40 ±
Output resistance	350 Ohm
Tolerance output resistance	1 ±
Insulation resistance	2x10 ⁹ Ohm
Rated range of excitation voltage f	2.5 ... 5 V
Operating range of excitation voltage f	1 ... 10 V
Zero signal	0.05 mV/V
Rated output	1 mV/V / FS

Precision

Accuracy class	0,5%
Relative linearity error	0.1 %FS
Relative zero signal hysteresis	0.05 %FS
Temperature effect on zero signal	0.02 %FS/K
Temperature effect on characteristic value	0.02 %RD/K
Relative creep	0.1 %FS

Connection Data

Connection type	6 conductor open
Name of the connection	Unitronic FD CP Plus / 3x2x0,14
Cable length	3 m

Temperature

Rated temperature range f	-10 ... 70 °C
Operating temperature range f	-10 ... 85 °C
Storage temperature range f	-10 ... 85 °C



Environmental protection

IP67







Abbreviation: RD: „Reading“; FS: „Full Scale“;

1) The exact nominal sensitivity is indicated in the test report;

Pin Configuration

Symbol	Description	Wire colour
Ub	Supply voltage (depends on variant)	brown
GND	Ground power supply	white
Ua (Out)	Output signal 4... 20mA / 0... 10V / 0... 5V	green
Tara (Ta)	Control input for zero balance	yellow
Scale (Sc)	Control input for amplification factor	grey
GND	Ground, signal	pink
	Shield	transparent

accessories

Description	Description
	<p>Calibration Certificate kn/20/5 Factory calibration certificate for force to 20 kN in accordance with DIN EN ISO / IEC 17025 for test materials monitoring according to DIN ISO 9001: 2008 with 5 load levels and 3 series of measurements.</p>
	<p>GSV-1H Measuring amplifier in top-hat rail housing for sensors with straingages. Analogue output -10V...+10V, limiting frequency 250Hz, 4 input sensitivities from 2.0mV/V.</p>
	<p>GSV-2TSD-DI Measuring amplifier in desktop-housing for sensors with straingages. Serial port RS232, USB port, analogue output -5V...+5V, limiting frequency 260Hz, input sensitivity 3.5mV/V.</p>
	<p>GSV-3USB Measuring amplifier in aluminum housing for sensors with straingages. Limiting frequency 1250Hz, input sensitivity 2 / 3,5 / 10 mV/V.</p>
	<p>GSV-6K Analogue measuring amplifier in plug housing for sensors with strain gauges. Analogue output configurable, TEDS, sampling frequency 10Hz ... 25kHz, input sensitivity configurable 0.1mV/V ... 8mV/V</p>
	<p>Configuration amplifier As a free service, we offer the setting of calibration factors in the memory of the measuring amplifier</p>
	<p>High Accuracy Calibration/1D</p>