

K6D110 1kN/100Nm/MP11



Description

The multi-component sensor K6D110 allows force and torque measurement in three mutually perpendicular axes.

The multi-component sensor K6D110 is characterized by a big measuring range for torques at the same time with the small outer diameter.

With this multi-component sensor of the „second generation“ is used rod construction, which absorbs forces and torques directly on the pitch circle of the fastening thread.

The force transmission is applied on the 1 mm raised segments. The inner diameter of segments is used for the centering. Due to segmented, ring-shaped front surface, the optimal force transmission and therefore the best possible reproducibility in the range of about 0,1 % will be obtained.

The multi-component force sensor is very well suited for use in robotics, e.g.

- For collision detection
- "Teach-In"
- Collision detection
- Force or torque-controlled operation
- Load measurement in medicine, prosthetics, orthopaedic engineering
- Measurement in sports medicine
- Comfort / ergonomics measurements

The force and torque loadings are evaluated e.g. using a GSV-8AS measurement amplifier or an integrated electronic of type GSV-6.

The sensor K6D110 4kN/250Nm is made of aluminium alloy, the sensor K6D110 10kN/750Nm is made of high-strength stainless steel 1.4542.

Dimensions

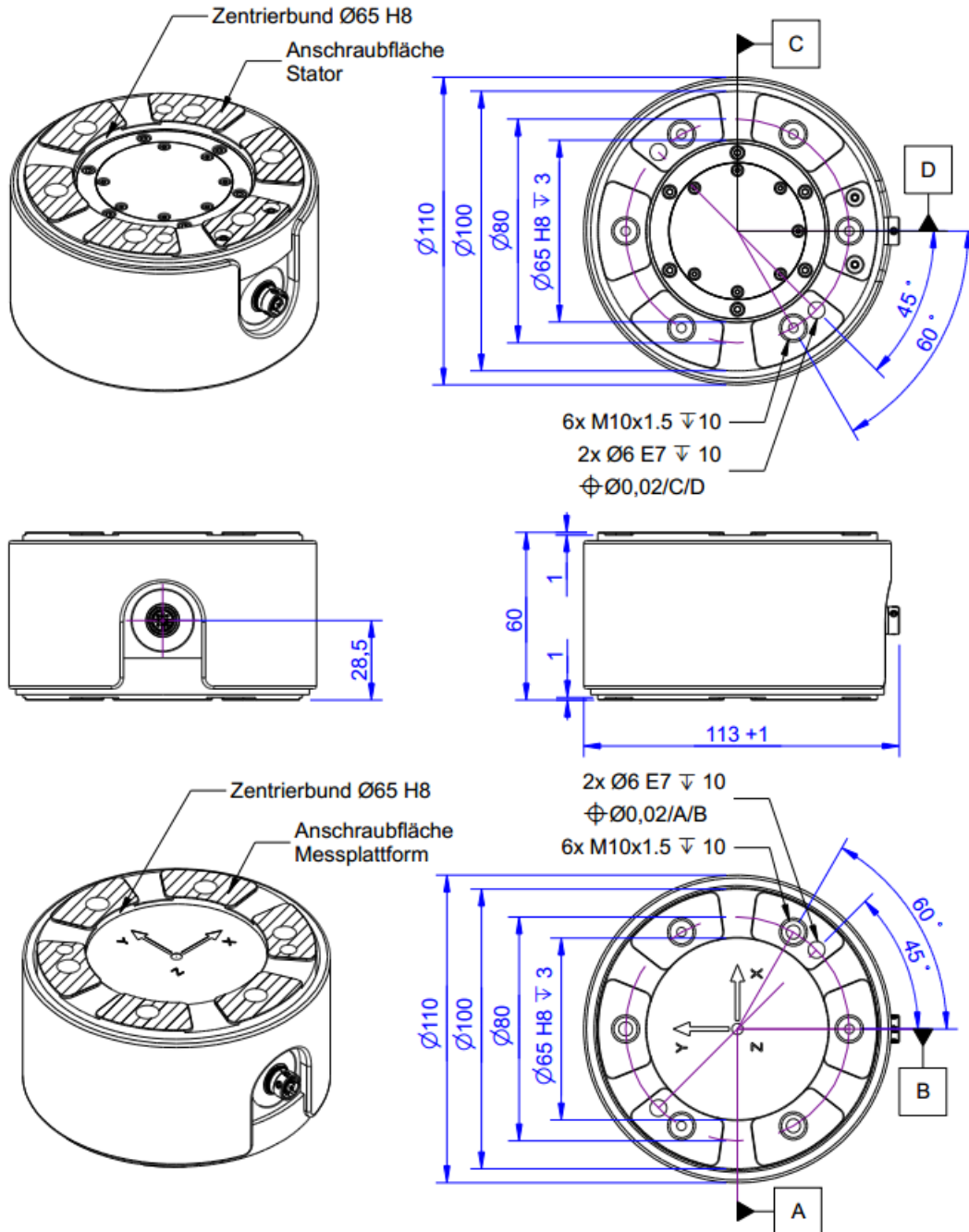

Technical Data

Force sensor

Type	6-Axis force sensor
Force direction	Tension / Compression
Rated force Fx	1 kN
Rated force Fy	1 kN
Rated force Fz	2.5 kN
Force introduction	Inner thread
Dimension 1	6x M10x1,5
Sensor Fastening	Inner thread
Dimension 2	6x M10x1,5
Operating force	300 % FS
Material	Aluminium alloy
Dimensions	Ø110 x 60 mm
Height	60 mm
Length or Diameter	110 mm
Rated torque Mx	100 Nm
Rated torque My	100 Nm
Rated torque Mz	100 Nm
Torque limit	300 % FS
Bending moment limit	300 % FS

Electrical Data

Input resistance	350 Ohm
Tolerance input resistance	10 Ohm
Output resistance	350 Ohm
Tolerance output resistance	10 Ohm
Insulation resistance	2 GOhm
Rated range of excitation voltage f	2.5 ... 5 V
Operating range of excitation voltage f	1 ... 5 V
Zero signal to	-0.05 mV/V
Zero signal from	0.05 mV/V
characteristic value range min	0.4 mV/V
characteristic value range max	0.8 mV/V

Precision

Accuracy class	0,2%
Relative linearity error	0.1 %FS
Relative zero signal hysteresis	0.1 %FS
Temperature effect on zero signal	0.1 %FS/K
Temperature effect on characteristic value	0.01 %RD/K
Relative creep	0.1 %FS
Relative repeatability error	0.5 %FS

Connection Data

Connection type	24 conductor open
-----------------	-------------------



Name of the connection round plug connector MP11, 24-
pole, male

Eccentricity and Crosstalk

Crosstalk 1 %FS

Temperature

Rated temperature range f	-10 ... 70 °C
Operating temperature range f	-10 ... 85 °C
Storage temperature range f	-10 ... 85 °C
Environmental protection	IP65

Abbreviation : RD: „Reading“; FS: „Full Scale“;

The application of a calibration matrix is required for the determination of the forces F_x , F_y , F_z and moments M_x , M_y , and M_z from the 6 measurement channels, and to compensate for the crosstalk.

The calibration data are individually determined and documented for the sensor.

The measurement error is expressed individually by the specification of the extended measurement uncertainty ($k = 2$) for the forces F_x , F_y , F_z , and moments M_x , M_y , M_z .

Pin Configuration

Channel	Symbol	Description	Wire colour	PIN
1	+Us	positive bridge supply	white	1
	-Us	negative bridge supply	brown	2
	+Ud	positive bridge output	green	3
	-Ud	negative bridge output	yellow	4
2	+Us	positive bridge supply	gray	5
	-Us	negative bridge supply	pink	6
	+Ud	positive bridge output	blue	7
	-Ud	negative bridge output	red	8
3	+Us	positive bridge supply	black	9
	-Us	negative bridge supply	purple	10
	+Ud	positive bridge output	gray-pink	11
	-Ud	negative bridge output	red-blue	12
4	+Us	positive bridge supply	white-green	13
	-Us	negative bridge supply	brown-green	14
	+Ud	positive bridge output	white-yellow	15
	-Ud	negative bridge output	yellow-brown	16
5	+Us	positive bridge supply	white-gray	17
	-Us	negative bridge supply	gray-brown	18
	+Ud	positive bridge output	white-pink	19
	-Ud	negative bridge output	pink-brown	20
6	+Us	positive bridge supply	white-blue	21
	-Us	negative bridge supply	brown-blue	22
	+Ud	positive bridge output	white-red	23
	-Ud	negative bridge output	brown-red	24

Shield: connected with sensor housing;

Manual

Stiffness Matrix K6D110 1kN/100Nm

34.3 kN/mm	0.0	0.0	0.0	1030 kN	0.0	u_x
0.0	34.3 kN/mm	0.0	-1030 kN	0.0	0.0	u_y
0.0	0.0	140.8 kN/mm	0.0	0.0	0.0	u_z
0.0	-1030 kN	0.0	124.8 kNm	0.0	0.0	ϕ_{ix}
1030 kN	0.0	0.0	0.0	124.8 kNm	0.0	ϕ_{iy}
0.0	0.0	0.0	0.0	0.0	91.6 kNm	ϕ_{iz}

Element	Description
[kN/mm]	force- displacement
[kNm]	torque- twist
[kN]	force- twist and torque- displacement













Mounting

The forces is applied to an annulus ($\emptyset 100\text{-}\emptyset 65$) on the end faces of the sensor. No force is applied to the area inside the ring.

A centring hole is provided to secure the angular position.

accessories

Description	Description
 K6D-CalibrationMatrix SL	Standard calibration matrix "Small load" for the sensors with small measuring ranges
 K6D-CalibrationMatrix SL/Plus	High accuracy calibration matrix for 6-axis force/torque sensors;
 GSV-8DS	8-channel amplifier with USB port, analog output, UART interface. Other versions GSV-8AS CAN with Canbus and GSV-8AS EC with EtherCAT fieldbus.
 GSV-8AS	8-channel amplifier with USB port, analog output, 16x DIO, UART interface.
 K6D-Adapter Development	Indicative offer for an adapter set, Consisting of e.g. 2 plates, For mounting a device / flange on K6D sensor;
 Connection cable MP11/f-M16/24p/m	Connection cable for the K6D sensor to 8-channel measuring amplifier GSV-8AS
 Connection cable MP11/f-M16/24p/m/angled	Angled connection cable for the K6D sensor to 8-channel measuring amplifier GSV-8AS
 Connection cable MP11/f-open end	Connection cable for K6D sensor
 Connection cable MP11/f-D-Sub44HD/m	Connection cable for connecting the K6D sensor to an 8-channel measuring amplifier GSV-8DS SubD44HD
 Connection cable MP11/f-D-Sub44HD/m/straight	Straight connection cable for connecting the K6D sensor to an 8-channel measuring amplifier GSV-8DS SubD44HD
 Connection cable MP11/f-D-Sub44HD/m/angled	Angled connection cable for connecting the K6D sensor to an 8-channel measuring amplifier GSV-8DS SubD44HD