

GSV-8DS EC/SubD15HD



Highlights

- 8-channel amplifier
- 8x input configurable
- Full, half, quarter bridge, 120- 350- 1000 ohm, PT1000, $\pm 10V$, Thermocouple Type K, IEPE Sensors
- Outputs 1x USB port, 8x analog output $\pm 10V$, 4 ... 20mA configurable
- optional EtherCat, CANbus / CANopen
- optional external extensions Ethernet, Wi-Fi, LTE
- 16x Digital Input Output
- 5x galvanic isolation: analog input, analog output, digital IO, USB
- 8x 48kS / s simultaneous sampling
- 6-wire technology, bridge supply 2.5V, 5.0V, 8.75V configurable
- Digital filters IIR and FIR configurable
- Resolution $<20 \text{ nV} / V$

Description

The 8-channel measuring amplifier GSV-8 is characterized by particularly high resolution at data rates from 1 Hz to 48000 Hz. The 8 channels are recorded simultaneously, without multiplexing.

As communication interfaces USB port, optional EtherCAT or CANbus are available.

The device has 8 configurable analog outputs ($\pm 10V$ et al and 4 ... 20mA).

There are 8 analog inputs. They are individually configurable as:

- DMS input for full bridges in 4- and 6-wire technology
- DMS input for half-bridges
- DMS input for quarter-bridge 120 ohms, 350 ohms, 1kOhm
- Single-ended input $\pm 10V$
- Input for PT1000 temperature sensor,
- Input for thermocouple type K.

Sensors with IEPE (ICP) interface can be connected via an adapter plug with BNC socket, e.g. IEPE acceleration sensors, IEPE force sensors, etc.

The measuring amplifier GSV-8DS SubD44 is equipped with industrial connectors SubD44HD. This connector is suitable for connection of

- 1x 6-axis sensor K6D or alternatively with
- 2x for DMS 0-45-90 rosettes or 2x 3-axis sensors;
- 1x for 2 DMS T rosette or 1x 2-axis sensors;

The inputs 1 to 6 are connected in parallel on the connectors 1/6 to the inputs on the connectors 1/3 and 4/6.

Dimensions

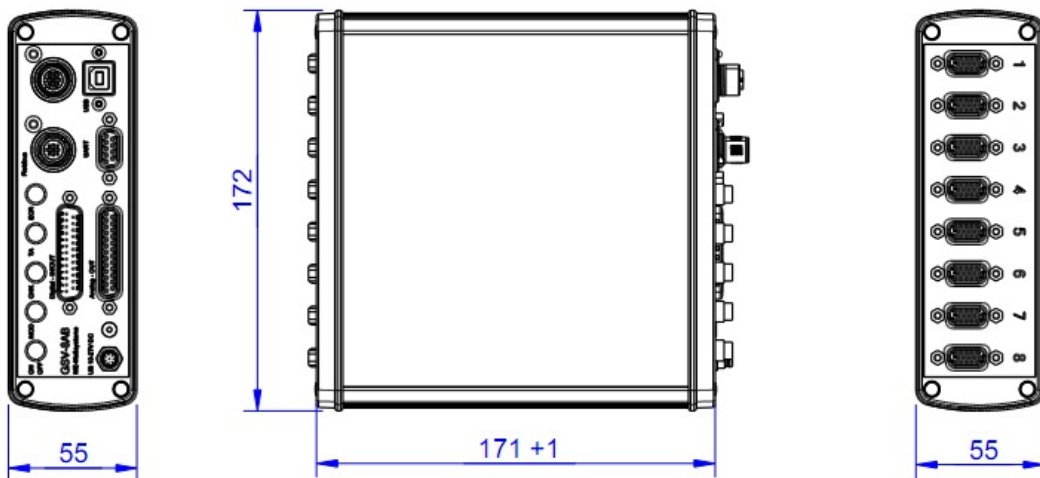
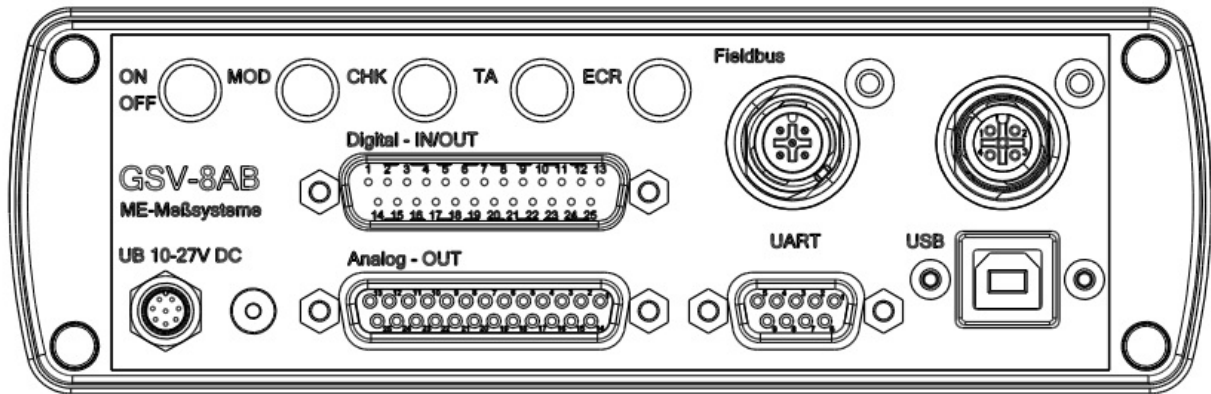
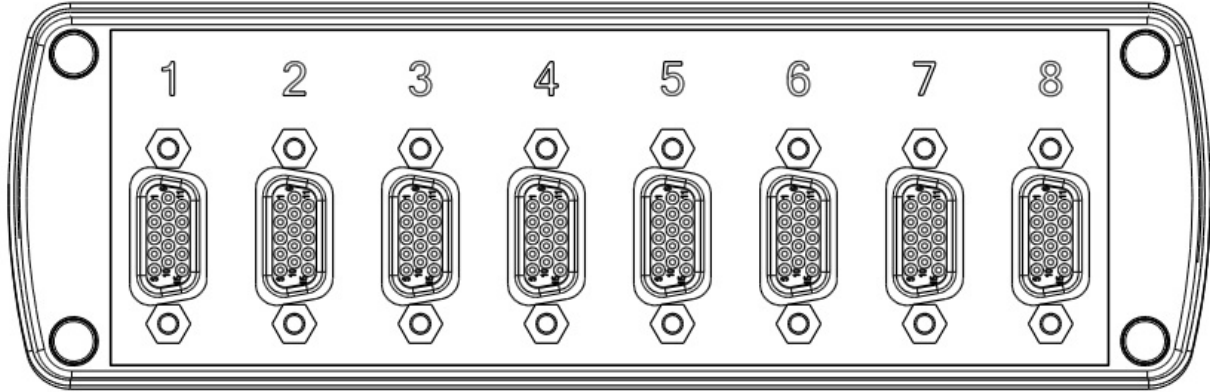

Technical Data

Input analog

Input sensitivity-steps	2.0 3.5 7	mV/V
Input resistance strain-gauge-full-bridge	60 ... 5	Ohm
Input voltage f	-10 ... 10	V
Input resistance-voltage	10	MOhm
Temperature input-type	PT1000	
Temperature-measuring range from	-230	°C

Output analog

Number of analog outputs	8	
Voltage output f	-10 ... 10	V
Output resistance - voltage	50	Ohm
Current output f	4 ... 20	mA
Output resistance - current	350	Ohm
Isolation of the analog output	2	kV

Measuring frequency

Data frequency f	0 ... 48000	Hz
------------------	-------------	----

Supply

Supply voltage f	12 ... 28	V
Strain gauge bridge supply	5 2.5 8.75	V

Interface

Type of the interface	usb ethercat teds
Quantity of the interface	2
Version of the interface	USB 2.0 Fullspeed, EtherCat Fieldbus

Temperature

Rated temperature range f	0 ... 50	°C
Operating temperature range f	-20 ... 70	°C
Environmental protection	IP64	

Basis Data

Dimensions	172 x 172 x 55	mm
Housing	Aluminium	
Connection	Connector	
Connection type	Sub-D15HD	
Number of channels	8-Kanal	







Precision

Accuracy class	0,05%
----------------	-------



Relative linearity error	0.02	%FS
Resolution	24	Bit

accessories

	Description	Description
	Adapter SubD15HD	Adapter Sub-D 15-pin HD to terminal block for connection to the measuring amplifier GSV-8DS
	Mounting-FEET-200	Mounting plates for GSV-1A8 / GSV-1A8USB / GSV-8DS
	Adapter Sub-D 25	Adapter Sub-D 25-pin to 27-pin terminal block for connection to the measuring amplifier GSV-8DS
	GSV-8DS Sync-cable/n	Sync cable for several 8-channel amplifiers GSV-8DS
	GSV-8DS IEPE/BNC/SubD15HD	Adapter for connecting IEPE sensors to GSV-8DS;
	GSV-8 Rack	Rack for the measuring amplifier GSV-8DS, synchronizes up to 5x GSV-8DS or up to 40 channels
	GSV-8 Key guard	protection against pressing the buttons on the measuring amplifier GSV-8DS



Order options

Type	Description
GSV-8DS SubD15HD	8 SUB-D15 HD inputs for sensor
GSV-8DS CAN/SubD15HD	8 SUB-D15 HD inputs for sensor, variant with CANbus / CANopen
GSV-8DS EC/SubD15HD	8 SUB-D15 HD inputs for sensor, variant with EtherCat Fieldbus
GSV-8DS SubD44HD	4 pieces Sub-D44HD
GSV-8DS CAN/SubD44HD	4 pieces Sub-D44HD, variant with CANbus / CANopen
GSV-8DS	4 pieces Sub-D44HD, variant with EtherCat Fieldbus