

KM40 500N



Description

The force sensor KM40 is a precision force sensor in membrane construction for the measurement of compressive forces. The force sensor is fastened to a flat surface with four screws M4. There is a spherical cap with a radius of 50 mm provided for the force transmission. The force is applied with a flat plate against the cap. The strength introduction occurs with a flat plate against the cap.

The hardness of the spherical cap is HRC 54.

A flattening of the spherical cap from a load of about 20kN is therefore possible.

Environmental protection rating is IP 67.

In contrast to the force sensors KD, KD's and LC series lateral forces from about 5% the original naming power can lead to a measurement error greater than 1%. Therefore, the force transmission must be centric.

Dimensions

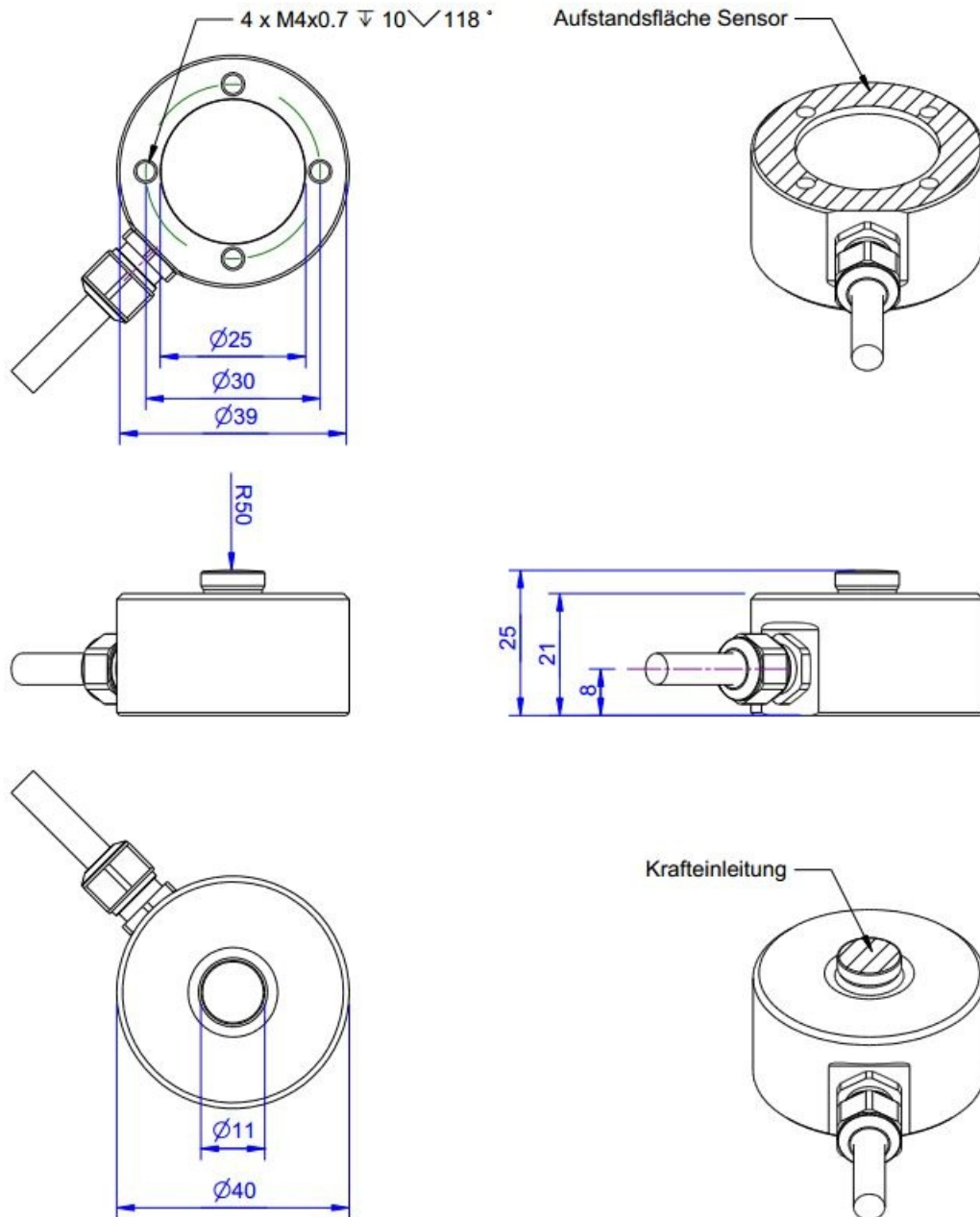

Technical Data

Force sensor

Type	Load cell
Force direction	Compression
Rated force Fx	500 N
Force introduction	Load button
Dimension 1	Ø11x4
Sensor Fastening	Circular ring
Dimension 2	Ø40x7,5
Operating force	150 %FS
Rated displacement	0.07 mm
Lateral force limit	50 %FS
Material	Stainless steel
Natural frequency	5 kHz
Height	25 mm
Length or Diameter	40 mm

Electrical Data

Input resistance	390 Ohm
Tolerance input resistance	40 ±
Output resistance	350 Ohm
Tolerance output resistance	1 ±
Insulation resistance	2x10 ⁹ Ohm
Rated range of excitation voltage f	2.5 ... 5 V
Operating range of excitation voltage f	1 ... 10 V
Zero signal	0.05 mV/V
Rated output	1 mV/V / FS

Precision

Accuracy class	0,5%
Relative linearity error	0.1 %FS
Relative zero signal hysteresis	0.05 %FS
Temperature effect on zero signal	0.02 %FS/K
Temperature effect on characteristic value	0.02 %RD/K
Relative creep	0.1 %FS

Connection Data

Connection type	4 conductor open
Name of the connection	Unitronic FD CP Plus / 4x0,14
Cable length	3 m

Temperature

Rated temperature range f	-10 ... 70 °C
Operating temperature range f	-10 ... 85 °C
Storage temperature range f	-10 ... 85 °C



Abbreviation: RD: „Reading“; FS: „Full Scale“;

1) The exact nominal sensitivity is indicated in the test report;









Pin Configuration

Symbol	Description	Wire colour
+Us	positive bridge supply	brown
-Us	negative bridge supply	white
+Ud	positive bridge output	green
-Ud	negative bridge output	yellow

Pressure load: positive output signal.

Shield- transparent.

accessories

	Description	Description
	Calibration Certificate kn/20/5	Factory calibration certificate for force to 20 kN in accordance with DIN EN ISO / IEC 17025 for test materials monitoring according to DIN ISO 9001: 2008 with 5 load levels and 3 series of measurements.
	GSV-1H	Measuring amplifier in top-hat rail housing for sensors with strain gauges. Analogue output -10V...+10V, limiting frequency 250Hz, 4 input sensitivities from 2.0mV/V.
	High Accuracy Calibration/1D	
	GSV-2TSD-DI	Measuring amplifier in desktop-housing for sensors with strain gauges. Serial port RS232, USB port, analogue output -5V...+5V, limiting frequency 260Hz, input sensitivity 3.5mV/V.
	GSV-3USB	Measuring amplifier in aluminum housing for sensors with strain gauges. Limiting frequency 1250Hz, input sensitivity 2 / 3,5 / 10 mV/V.
	GSV-6K	Analogue measuring amplifier in plug housing for sensors with strain gauges. Analogue output configurable, TEDS, sampling frequency 10Hz ... 25kHz, input sensitivity configurable 0.1mV/V ... 8mV/V