

## Force Sensor KD80s 100N

Item number: 10357



The force sensor KD80s is used for tensile and compressive force measurements and for weighing.

The areas of application are e.g. wire rope measurements, test beds, overload securing for lifting tools, process controllers as well as weighing scales.

The force sensor KD80s for the standard temperature range will be delivered with cable Unitronic FD CP Plus 4x0,14. The cable is suitable for drag chains.

The force sensor KD80s HT is used for the maximum operating temperature of 150°C. For this temperature range of 150°C the sensor will be delivered with 6-wire high temperature resistant cable ALMI HAFL-C MOD. SO 6x0,15mm<sup>2</sup>.

The KD80s sensors have accuracy class of 0,05%. The environmental protection is IP65.

### Optional special version

- Protection class IP68: from rated force 200 N
- Pressure range up to 8 bar

## Technical Drawing

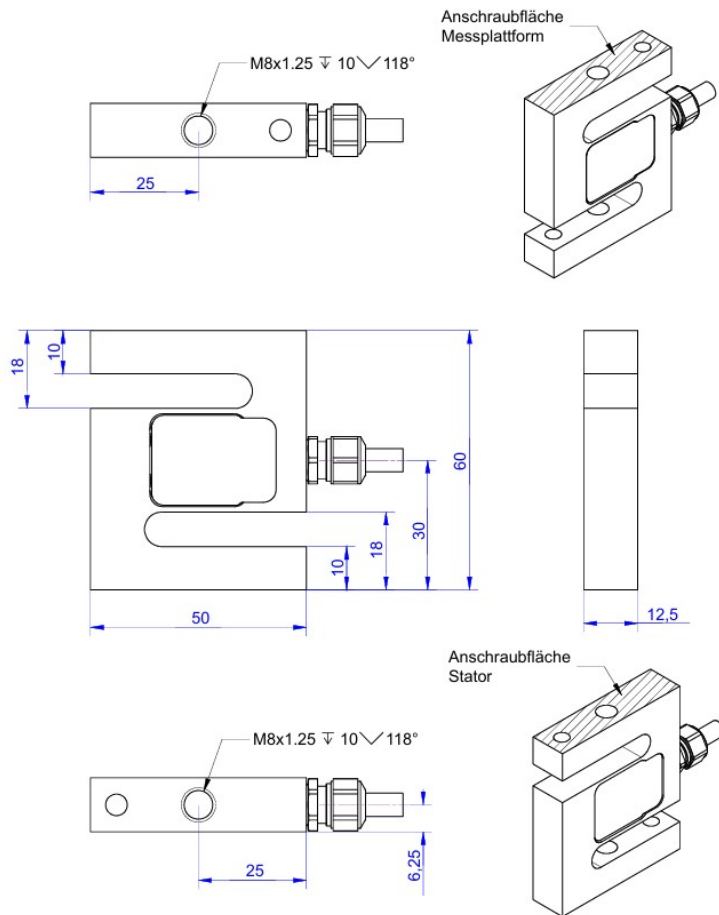

## Technical Data

Basic Data		Unit
Type	Kraftsensor	
Force direction	Tension/Compression	
Rated force Fx	100	N
Force introduction	Internal thread	
Dimension 1	M8x1,25	
Sensor Fastening	Internal thread	
Dimension 2	M8x1,25	
Operating force	150	%FS
Rated displacement	0.2	mm
Lateral force limit	100	%FS
Material	aluminum-alloy	
Natural frequency fx	5	kHz
Dimensions	60mm x 50mm x 10mm ... 200mm x 150mm x 60mm	
Height	60	mm
Length or Diameter	50	mm
Bending moment limit	5	Nm
Variants	100N... 200kN	

Electrical Data		Unit
Input resistance	400	Ohm
Tolerance input resistance	50	Ohm
Output resistance	350	Ohm
Tolerance output resistance	10	Ohm
Insulation resistance	5	GOhm
Rated range of excitation voltage from	2.5	V
Rated range of excitation voltage to	5	V
Operating range of excitation voltage from	1	V
Operating range of excitation voltage to	10	V
Zero signal	0.05	mV/V
Rated output	2	mV/V / FS

Accuracy Data		Unit
Accuracy class	0,05	
Relative linearity error	0.02	%FS
Relative zero signal hysteresis	0.02	%FS
Temperature effect on zero signal	0.02	%FS/K
Temperature effect on characteristic value	0.01	%RD/K
Relative creep	0.1	%FS

Environmental Data		Unit
Rated temperature range from	-10	°C
Rated temperature range to	70	°C
Operating temperature range from	-10	°C
Operating temperature range to	85	°C
Storage temperature range from	-10	°C
Storage temperature range to	85	°C
Environmental protection	IP65	

Abbreviation: RD: „Reading“; FS: „Full Scale“;1) The exact nominal sensitivity is indicated in the test report;

## Pin Assignment

Channel	Symbol	Description	Wire color	PIN
	+Us	positive bridge supply	brown	
	-Us	negative bridge supply	white	
	+Ud	positive bridge output	green	
	-Ud	negative bridge output	yellow	

Pressure load: positive output signal.  
Shield- transparent.