

## Force Sensor KD34s 5N

Item number: 5658

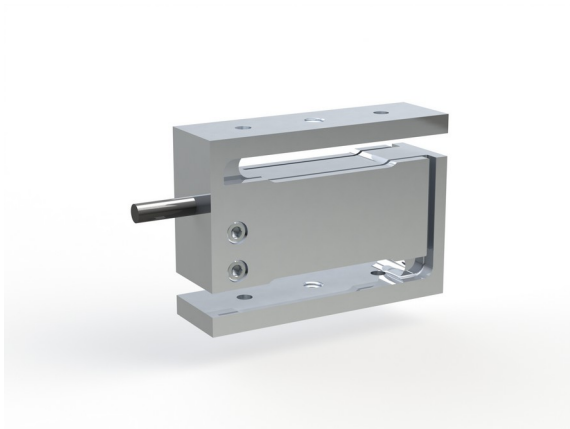

The force sensor KD34s was specially designed for measuring of the smallest forces. Due to integrated stop against overload is this sensor also in measuring range of 0,25 N and 0,5 N even safer to use. In the 0,5 N version special strain gauges of platinum- nickel alloy are used with higher input sensitivity by factor 2 to conventional strain gauges of constantan.

The stiffness of the sensors 0.25N and 0.5N is therefore identical.

In addition to M3 threads for the force transmission, force sensor also has boreholes diameter  $\varnothing 2$ , which are used for orientation of the force sensor or for mounting of adapters.

### Optionale Sonderausführung

- Druckbereich bis 8 bar

## Technical Drawing

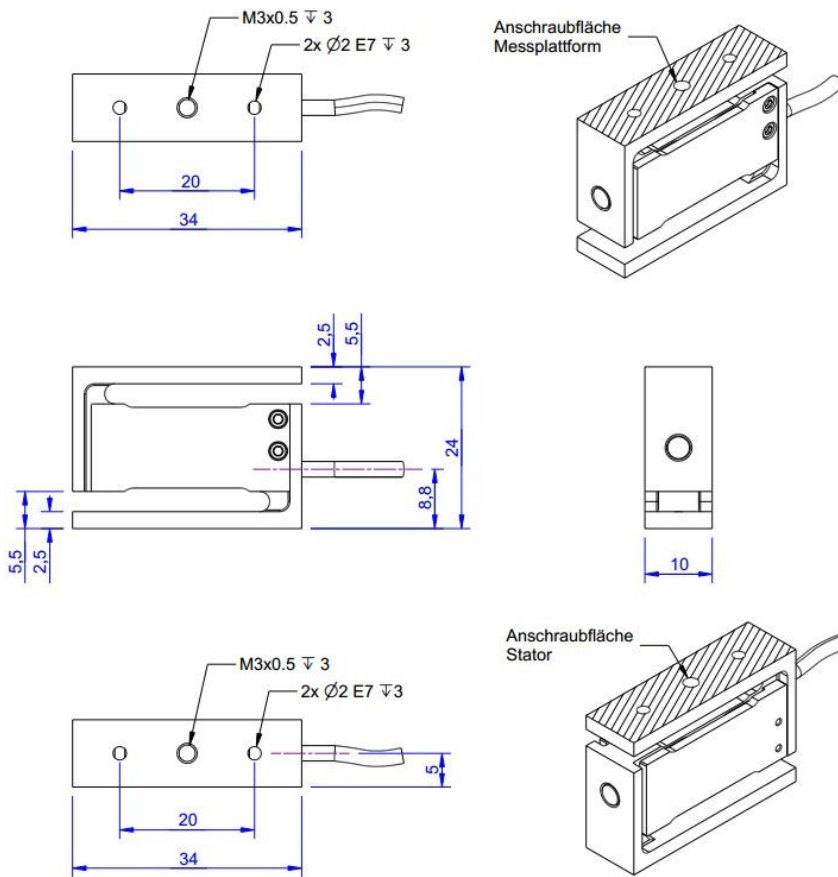

## Technical Data

Basic Data		Unit
Type	Kraftsensor	
Force direction	Tension/Compression	
Rated force Fx	5	N
Force introduction	Internal thread	
Dimension 1	M3x0,5	
Sensor Fastening	Internal thread	
Dimension 2	M3x0,5	
Operating force	200	%FS
Rated displacement	0.2	mm
Lateral force limit	100	%FS
Material	aluminum-alloy	
Natural frequency fx	300	Hz
Dimensions	24mm x 34mm x 10mm	
Height	24	mm
Length or Diameter	34	mm
Variants	250mN... 10N	

Electrical Data		Unit
Input resistance	390	Ohm
Tolerance input resistance	40	Ohm
Output resistance	350	Ohm
Tolerance output resistance	1.5	Ohm
Insulation resistance	5	GOhm
Rated range of excitation voltage from	2.5	V
Rated range of excitation voltage to	5	V
Operating range of excitation voltage from	1	V
Operating range of excitation voltage to	10	V
Zero signal	0.05	mV/V
Rated output	0.5	mV/V / FS

Accuracy Data		Unit
Accuracy class	0,1	
Relative linearity error	0.02	%FS
Relative zero signal hysteresis	0.02	%FS
Temperature effect on zero signal	0.02	%FS/K
Temperature effect on characteristic value	0.01	%RD/K
Relative creep	0.1	%FS

Environmental Data		Unit
Rated temperature range from	-10	°C
Rated temperature range to	70	°C
Operating temperature range from	-10	°C
Operating temperature range to	85	°C
Storage temperature range from	-10	°C
Storage temperature range to	85	°C
Environmental protection	IP65	

Abbreviation: RD: „Reading“; FS: „Full Scale“;1) The exact nominal sensitivity is indicated in the test report;Pressure load: positive output signal

## Pin Assignment

Channel	Symbol	Description	Wire color	PIN
	+Us	positive bridge supply	red	
	-Us	negative bridge supply	black	
	+Ud	positive bridge output	green	
	-Ud	negative bridge output	white	

Pressure load: positive output signal. Shield- transparent.